

Wayne
Dalton[®]
GARAGE DOORS

M O D E L

8850

CONTEMPORARY ALUMINUM
Central and East Region Availability



Black powder coated aluminum, White Laminated privacy glass



1 Choose Your Style

Standard Frames

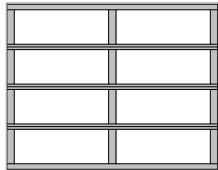

8' Wide (2 panel)*

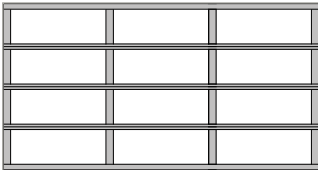

9'-12' Wide (3 panel)

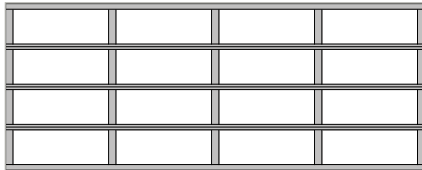

Over 12' Wide (4 panel)

Double-Wide Frames

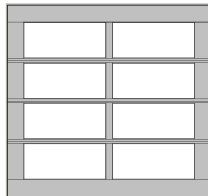

8" Wide (2 panel)*

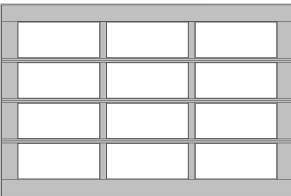

9' Wide (3 panel)

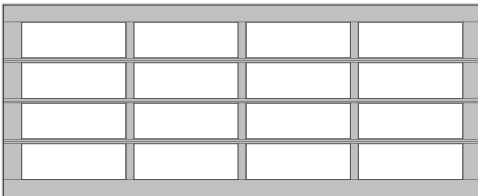

16' Wide (4 panel)

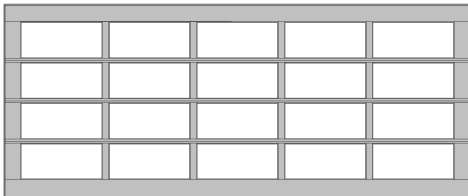

18' Wide (5 panel)**

Due to the weight of this door, it is only offered in the 6" frame.

Panel spacing drawings shown are for illustrative purposes only and do not reflect actual stile and rail dimensions. 8" double wide rails and double end stiles apply only to larger doors and not available as options for smaller single doors.

If you are ordering a 16'3" or wider door as well as a single door, check with your dealer to ensure that the door frames match.
 *2 panel wide is optional for 9' doors.
 **Due to the weight of the 18' wide (5 panel) door, it is only offered in an 8" frame.



Brown painted aluminum, Satin Etched privacy glass

2 Choose Your Color

Anodized Finishes



Clear (Standard)



Dark Bronze

Painted Finishes

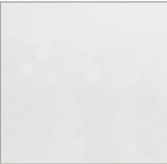

White



Brown

Powder Coat Finishes



Dark Bronze



Black

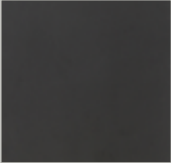

Black

RAL Powder Coat Finishes

Select from approximately 200 powder coat color options to best match your home.



Actual colors may vary from brochure due to fluctuations in the printing process. Always request a color sample from your Wayne Dalton dealer for accurate color matching.



Dark Bronze anodized aluminum, Satin Etched privacy glass

3 Choose Your Glass



Clear



Green Tinted



Gray Tinted



Bronze Tinted



Satin Etched



White Laminated



Obscure

Most panel styles are also available in both single pane and insulated configurations.

stylish.
colorful.
contemporary.

So versatile they are the perfect enhancement to your home's glass expanses and patios—beautifully fusing indoor and outdoor spaces. Wayne Dalton Contemporary Aluminum doors, constructed with a rugged, anodized aluminum frame, feature equal panel spacing for a clean modern look.

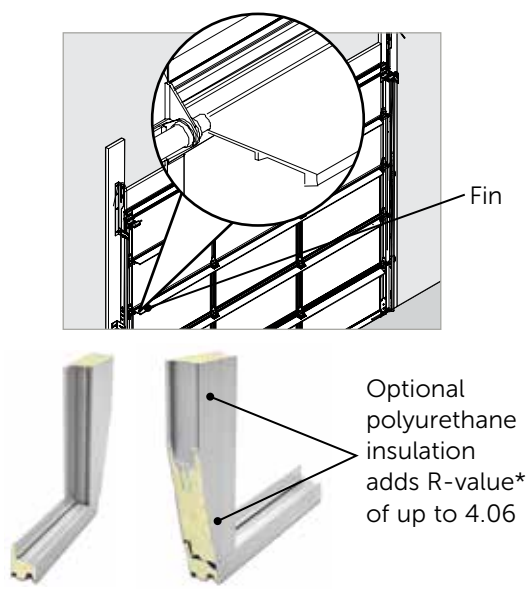

PERFORMANCE FEATURES

- Tongue-and-groove joints provide a great weather barrier
- Flexible vinyl bottom seal helps prevent dirt and elements from entering your garage
- Designed to be easy to maintain
- Constructed with rugged, anodized aluminum frame with equal panel spacing
- Reinforcing fins along with heavy-duty track and brackets help provide years of smooth, trouble-free operation (The fins are the extruded part of the door section that are not visible through the glass)
- Chose a 25,000 cycle spring for almost twice the life of a standard torsion spring

R-VALUES OF INSULATED 8850	9X7 DOOR	16X7 DOOR	9X8 DOOR	16X8 DOOR
1/2" insulated glass Solar Ban 70XL argon filled (R=3.125)	4.06	4.05	3.97	3.96
1/2" insulated glass (R=1.75) with polyurethane filled rails and stiles	2.87	2.86	2.76	2.74
1/2" insulated glass Low E (R=2.38) with polyurethane filled rails and stiles	3.42	3.40	3.31	3.30



Model 8850 offers a five-year limited warranty on the aluminum and one-year limited warranty on the glass. See full text of warranty for details.

* Wayne Dalton uses a calculated door section R-value for our insulated doors.

AFTER

BEFORE

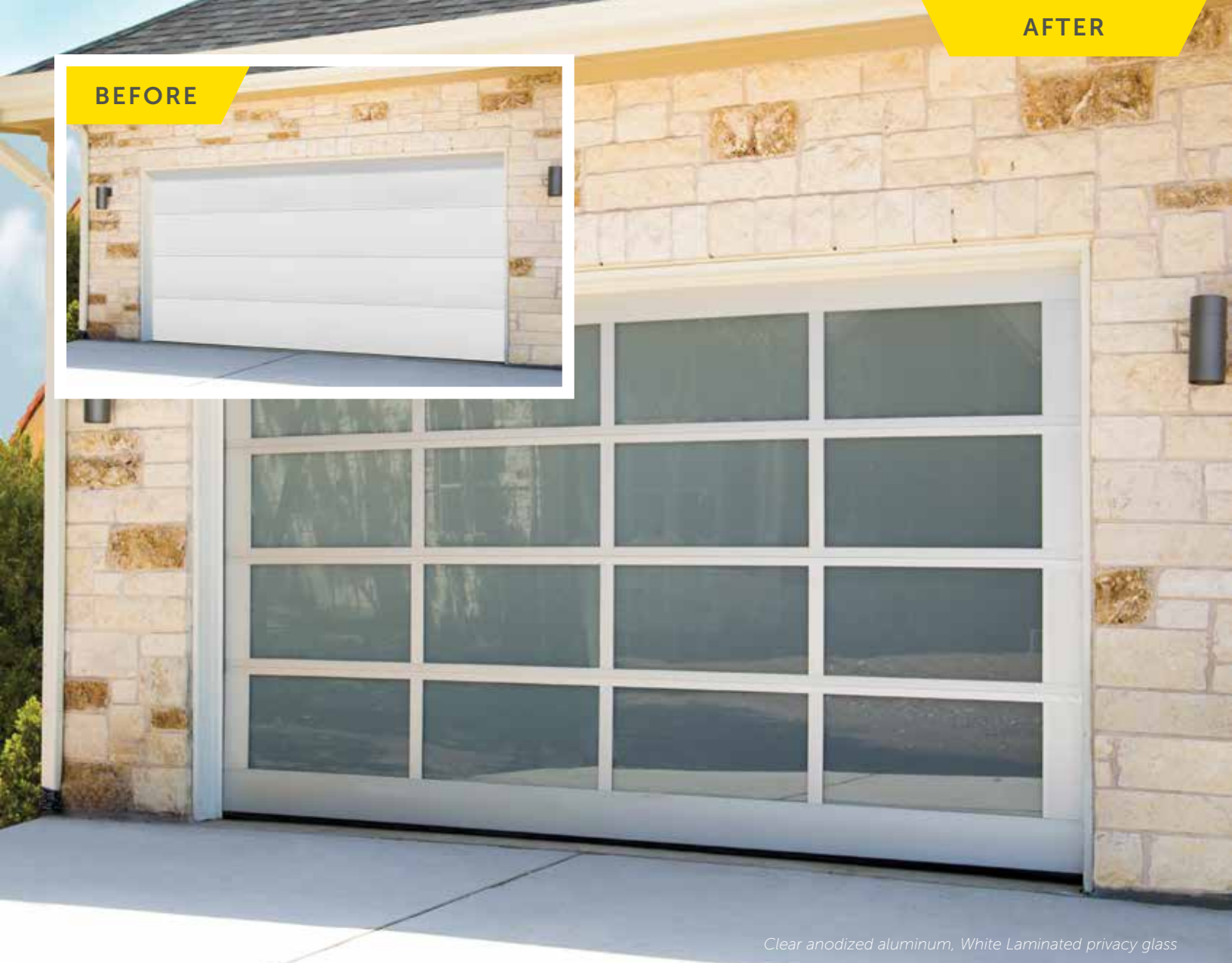

Clear anodized aluminum, White Laminated privacy glass



Garage Door Design Center

To see this door on your home, visit wayne-dalton.com and try our Garage Door Design Center. Upload a photo of your home and experiment with panel designs, color options, window styles and decorative hardware designs. Instant curb appeal awaits you with just a click of your mouse.

Wayne Dalton
GARAGE DOORS

DISTRIBUTED BY:

2501 S. State Hwy. 121 Bus., Ste 200
Lewisville, TX 75067

wayne-dalton.com



© 2018 Wayne Dalton, a Division of Overhead Door Corporation. Consistent with our policy of continuing product improvement, we reserve the right to change product specifications without notice or obligation. Item 341017 03/18